

Фонд НАУЧНИ ИСЛЕДВАНИЯ
МИНИСТЕРСТВО НА ОБРАЗОВАНИЕТО И НАУКАТА

Third-Party AAA, Charging and Billing Realization for Future Consumer-Oriented Wireless Communications

NexComm Congress 2023
April 24-28, 2023. Venice, Italy.

IARIA

Third-Party AAA, Charging and Billing Realization for Future Consumer-Oriented Wireless Communications



Ivan Ganchev^{1,2,3}

¹ University of Plovdiv "Paisii Hilendarski", BULGARIA
² Institute of Mathematics and Informatics – Bulgarian Academy of Sciences, BULGARIA
³ Telecommunications Research Centre (TRC), University of Limerick, IRELAND

Prof. Ivan GANCHEV
IEEE Senior Member
URSI Senior Member
ITU-T Invited Expert
IET Invited Lecturer

iganchev@hotmail.com

I. Ganchev "Third-Party AAA, Charging and Billing Realization for Future Consumer-Oriented Wireless Communications". NexComm 2023 Congress, April 24-28, 2023, Venice, Italy.



1

Presentation Outline

- Introduction
 - **Consumer**-Based techno-business Model (**CBM**)
- Third-Party Authentication, Authorization and Accounting (**3P-AAA**)
- Third-Party Charging and Billing (**3P-C&B**)
- Conclusion

I. Ganchev "Third-Party AAA, Charging and Billing Realization for Future Consumer-Oriented Wireless Communications". NexComm 2023 Congress, April 24-28, 2023, Venice, Italy.



2

INTRODUCTION

I. Ganchev "Third-Party AAA, Charging and Billing Realization for Future Consumer-Oriented Wireless Communications". NexComm 2023 Congress, April 24-28, 2023, Venice, Italy.



3

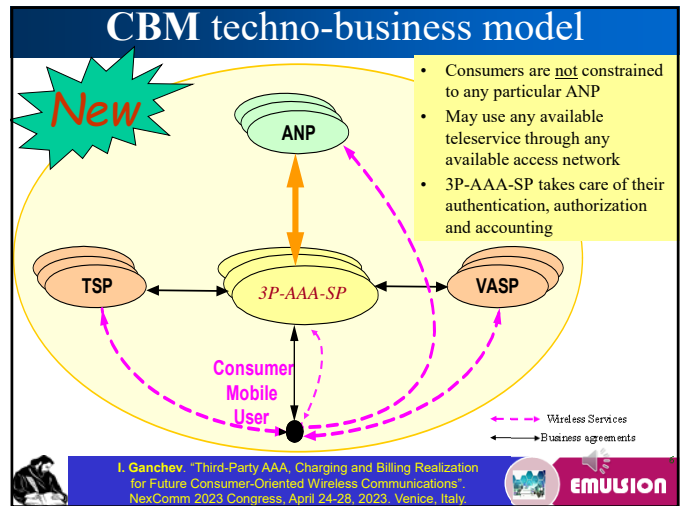

6

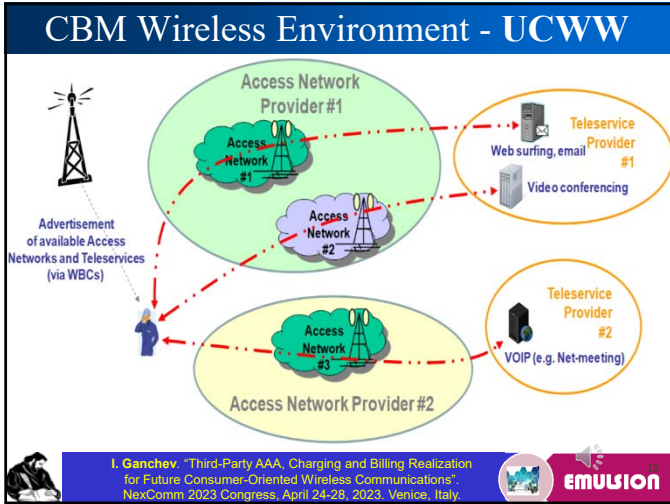

13

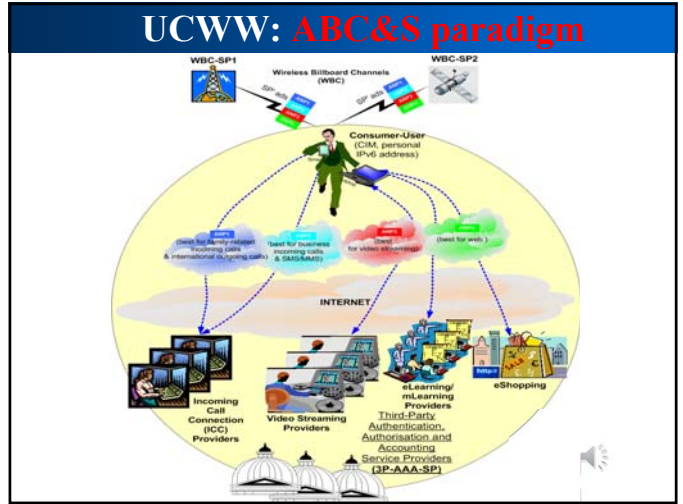

14

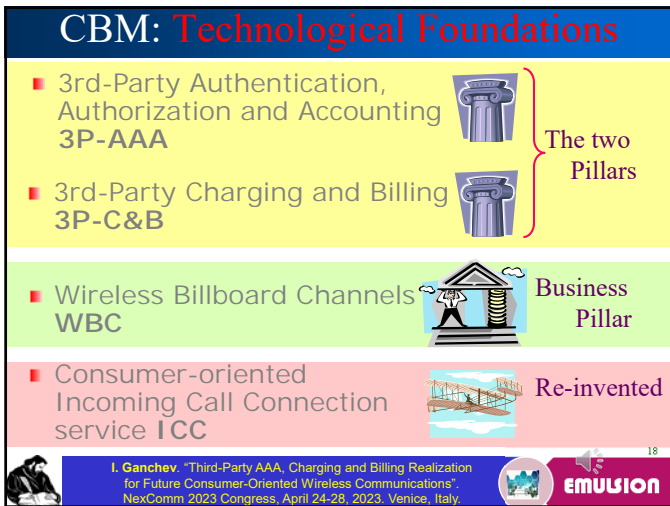

18

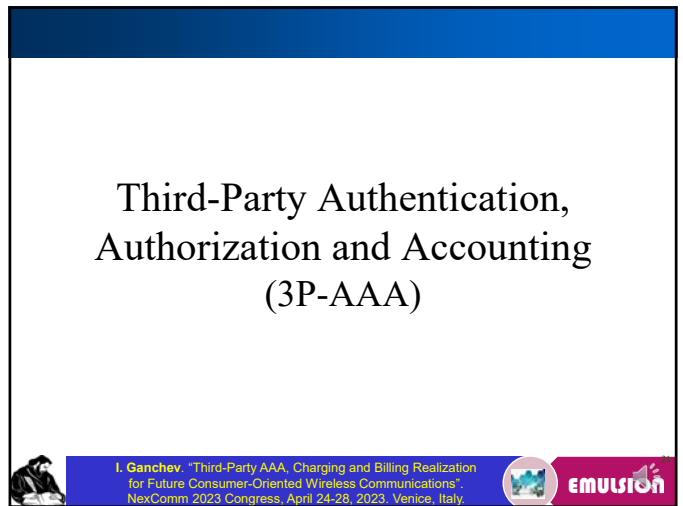

21

3P-AAA: Service and Service Providers

- 3P-AAA-SP are new business entities
- Central role
- Goal
 - Separation of the administration and management of users' AAA activity from the supply of a wireless access network service
- Status
 - Network-independent, autonomous, and trusted business entities

I. Ganchev "Third-Party AAA, Charging and Billing Realization for Future Consumer-Oriented Wireless Communications", NexComm 2023 Congress, April 24-28, 2023, Venice, Italy.



22

3P-AAA: Functional Model

Four principle interfaces:

- **a** (consumer ↔ ANP/TSP/VASP)
- **b** (consumer ↔ 3P-AAA-SP)
- **c** (ANP/TSP/VASP ↔ 3P-AAA-SP)
- **d** (3P-AAA-SP_{A/B/C} ↔ 3P-AAA-SP_{B/C/A})

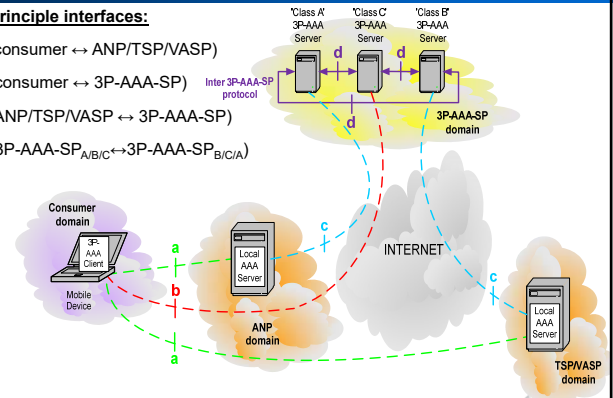

I. Ganchev "Third-Party AAA, Charging and Billing Realization for Future Consumer-Oriented Wireless Communications", NexComm 2023 Congress, April 24-28, 2023, Venice, Italy.



23

3P-AAA: Accounting

Accounting Sequences

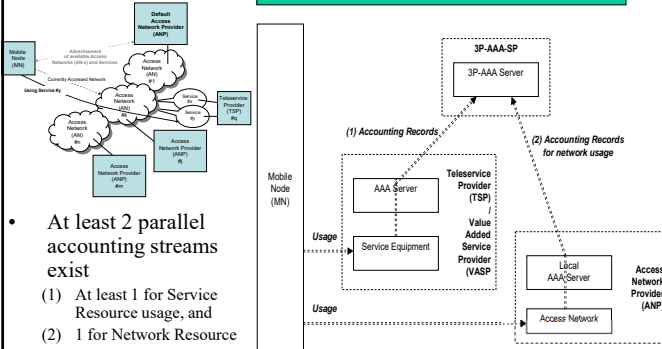

- At least 2 parallel accounting streams exist
- (1) At least 1 for Service Resource usage, and
- (2) 1 for Network Resource usage

I. Ganchev "Third-Party AAA, Charging and Billing Realization for Future Consumer-Oriented Wireless Communications", NexComm 2023 Congress, April 24-28, 2023, Venice, Italy.



26

3P-AAA: Accounting for Composite Services

Multiple Accounting Sequence

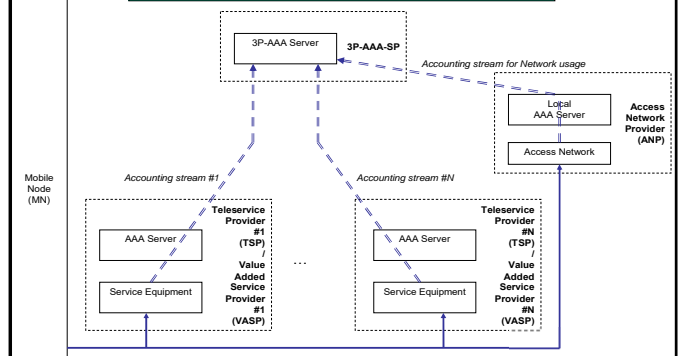

I. Ganchev "Third-Party AAA, Charging and Billing Realization for Future Consumer-Oriented Wireless Communications", NexComm 2023 Congress, April 24-28, 2023, Venice, Italy.



27

3P-AAA: Policy-based Accounting Model (cont.)

- Inter-Domain Accounting**
 - Separately administered domains involved
 - ANP/TSP/VASP
 - 3P-AAA-SP
 - Accounting policies exchange is needed between the AAA servers (e.g., by *pulling*)

| Step | Function | Description |
|------|-----------|-----------------------------------------------------------------|
| 1. | AccPolRQ | Policy is requested from the 3P-AAA Server |
| 2. | AccPolAns | 3P-AAA sends the Accounting back |
| 3. | AccRec | Accounting data sent from Teleservice Provider (TSP) AAA server |

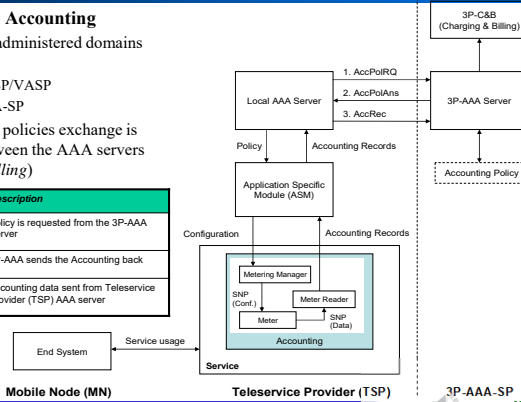

I. Ganchev "Third-Party AAA, Charging and Billing Realization for Future Consumer-Oriented Wireless Communications", NexComm 2023 Congress, April 24-28, 2023, Venice, Italy

29

3P-AAA: Policy-based Accounting Model Evaluation

- Integrated Accounting Service**
 - Accounting is coupled with the service
 - Accounting is tailored to the specific service
 - Specific service entity is used to generate accounting data
- Discrete Accounting Service**
 - Service providers outsource the accounting service
 - Independent accounting service providers provide the accounting services
 - Having generic accounting services could speed up service creation
- Inter-Domain Accounting**
 - This is appropriate for 3P-AAA usage
 - External accounting policies, stored on 3P-AAA domain, are sent to the service provider domain and the local AAA server enforces these on the corresponding service equipment for the provision of the actual service

- The preferred type for 3P-AAA is the **Discrete Accounting Service** because it is more flexible and generic
- The **Inter-Domain** arrangement is a good basis for 3P-AAA usage

I. Ganchev "Third-Party AAA, Charging and Billing Realization for Future Consumer-Oriented Wireless Communications", NexComm 2023 Congress, April 24-28, 2023, Venice, Italy

30

3P-AAA: Authorization Models

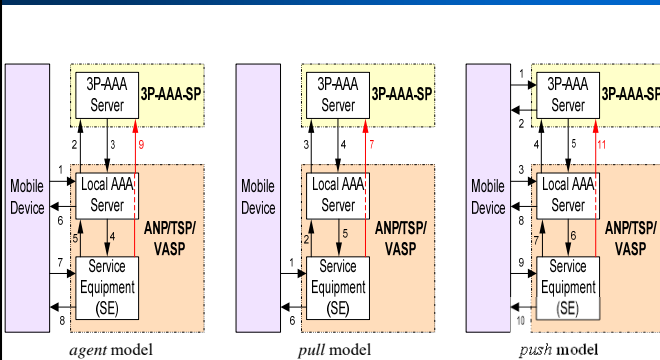

I. Ganchev "Third-Party AAA, Charging and Billing Realization for Future Consumer-Oriented Wireless Communications", NexComm 2023 Congress, April 24-28, 2023, Venice, Italy

32

Generic 3P-AAA Architecture

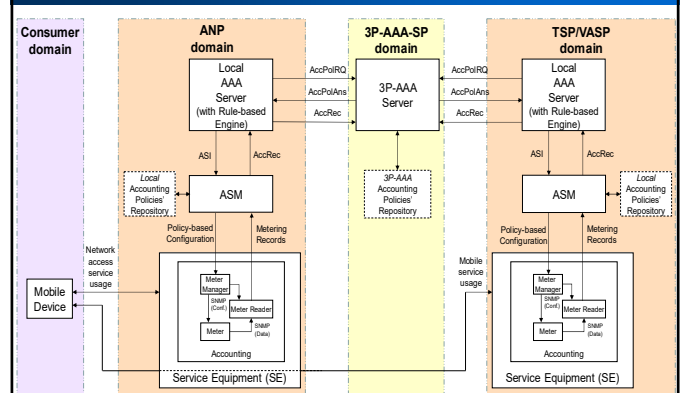

I. Ganchev "Third-Party AAA, Charging and Billing Realization for Future Consumer-Oriented Wireless Communications", NexComm 2023 Congress, April 24-28, 2023, Venice, Italy

36

Third-Party Charging and Billing (3P-C&B)

I. Ganchev, "Third-Party AAA, Charging and Billing Realization for Future Consumer-Oriented Wireless Communications", NexComm 2023 Congress, April 24-28, 2023, Venice, Italy



37

3P-AAA & 3P-C&B: 5-Layer Reference Model

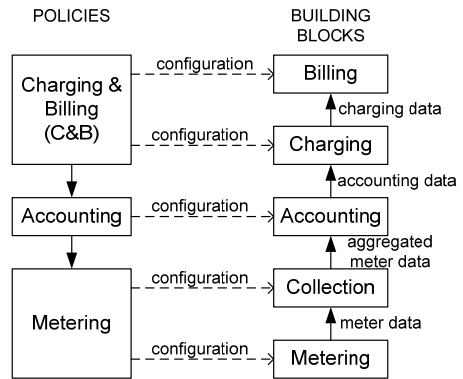

I. Ganchev, "Third-Party AAA, Charging and Billing Realization for Future Consumer-Oriented Wireless Communications", NexComm 2023 Congress, April 24-28, 2023, Venice, Italy



39

Generic 3P-C&B Architecture

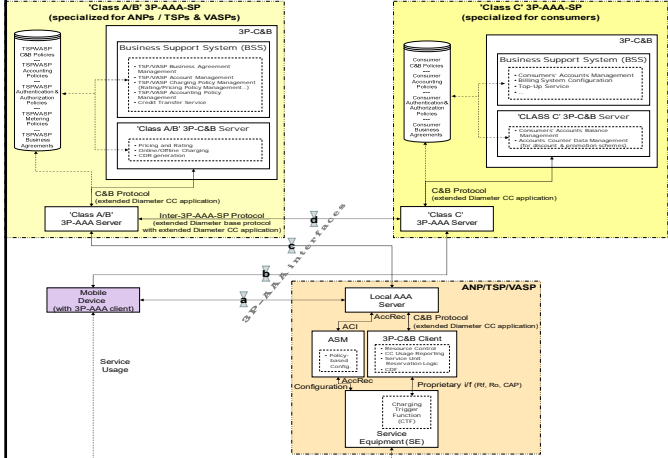

43

Inter-3P-AAA-SP Signaling Operations and Flows

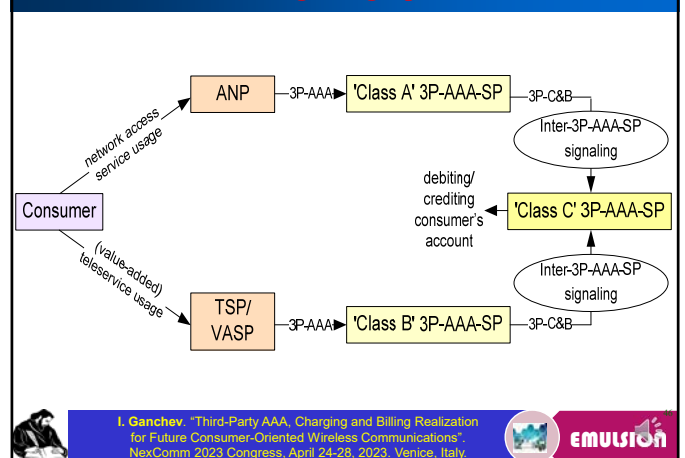

I. Ganchev, "Third-Party AAA, Charging and Billing Realization for Future Consumer-Oriented Wireless Communications", NexComm 2023 Congress, April 24-28, 2023, Venice, Italy



46

CONCLUSION



I. Ganchev "Third-Party AAA, Charging and Billing Realization for Future Consumer-Oriented Wireless Communications", NexComm 2023 Congress, April 24-28, 2023, Venice, Italy.

49

Conclusion

- A generic 3P-AAA and 3P-C&B solution has been described to serve the UCWW, established on the CBM model.
- The main technological foundations for the 3P-AAA and 3P-C&B provisioning have been described.
- A new Inter-3P-AAA-SP signaling protocol has been introduced to facilitate the charging interactions between different classes of 3P-AAA-SPs.
- The development of this protocol, along with other supplementary protocols and applications for use in UCWW, briefly introduced in the presented proposals, is envisaged as part of the future R&D.



I. Ganchev "Third-Party AAA, Charging and Billing Realization for Future Consumer-Oriented Wireless Communications", NexComm 2023 Congress, April 24-28, 2023, Venice, Italy.

50

Conclusion: Strength with 3P-AAA-SP/3P-C&B Approach

- **Delivers fast innovative environment for service creation**
 - Service providers (ANP, TSP, VASP) do not need to invest in their own AAA and C&B system
 - Service providers can focus better on their services
 - Service providers get the AAA and C&B service for free
- **Delivers a 'fair system'**
 - Consumers chooses which service provider (ANP/TSP/VASP) and which service they are going to use (in that point of view, every service provider has equal chances!)
 - Consumer can freely seek for 'value for money' services
- **Helps create sophisticated AAA and C&B systems and services**
 - 3P-AAA-SPs can invest in their AAA and C&B services (for new charging schemes or flexible charging solutions) and these will automatically be available for every service provider and this would certainly result in more interest and new customers



I. Ganchev "Third-Party AAA, Charging and Billing Realization for Future Consumer-Oriented Wireless Communications", NexComm 2023 Congress, April 24-28, 2023, Venice, Italy.

51

End

Thank you !

Questions & comments ?

Acknowledgments to Dr. Máirtín O'Droma & Mr. Jeno Jakab for their contributions to this work.

The work has emanated from research conducted with the financial support of the Bulgarian National Science Fund (BNSF) under the Grant No. KP-06-IP-CHINA/1 (КП-06-ИП-КИТАЙ/1).



I. Ganchev "Third-Party AAA, Charging and Billing Realization for Future Consumer-Oriented Wireless Communications", NexComm 2023 Congress, April 24-28, 2023, Venice, Italy.

53